



LEBOO

Healthcare Products Limited

Surgical Gowns, Surgical Drapes & Packs,
One Stop Solutions



About us

Leboo was founded by a professional team, with over 10 years' experience in the medical field in China. We have 2 factories and our company is aiming to provide high quality service to the healthcare, medical and industry area by producing disposable nonwoven and PE products, such as gowns, caps, masks, bed sheets, gloves, aprons, sleeve covers, shoe covers, as well as other products. To reach this objective, we built our 100,000 grade clean room in year 2014, giving the best guarantee of the product quality.

Commitment to quality

As a manufacturer of disposable products, Leboo is dedicated to providing the superior quality products, in this pursuit, Leboo have attained ISO 13485, CE 0197 and FDA, the most stringent international standards for producing quality products, as a result, Leboo's customer are able to benefit from lower costs and reduced products defects.

Good reputation

With many years exporting experience to Europe, U.S.A., South America, South Africa, Middle east and Asia, Leboo has established a solid reputation with stable prices, reliable supply and excellent services. We are confident in our ability to build even better reputation all over the world.

Our advantage

Rich experience on OEM service
High focus on customer needs
Strict quality control
Prompt delivery and competitive price
Professional and well- trained staff

Contents

Surgical Gown — 6-8

Surgical Gown
Doctor Set

Surgical Drape and Pack — 9-19

Basic Pack
Universal Pack
Laparotomy Pack
C-Section Pack
Delivery Pack
Orthopedic Pack
Eye Pack
Dental Pack
Arthroscopy Pack
Extremity Pack
Angiography Pack
Surgical Drape

Gown — 20-23

Isolation Gown
Patient Gown
Lab Coat
Covercall
PE Apron

Cap — 24-28

Surgeon Cap
Bouffant Cap
Mob Cap
Astro Cap
Surgical Hood

Face Mask — 27-28

Nonwoven Face Mask

Glove — 29-30

PE Glove

Shoe Cover and Sleeve Cover — 31-33

CPE Shoe Cover
Nonwoven Shoe Cover
Non-skid PP Shoe Cover
PP+CPE Shoe Cover
PE Boot Cover
PE Sleeve Cover

Bed Sheet — 34-35

Bed Sheet
Pillow Case
PE Mattress Cover

Leboo Certificates — 36



Surgical Gown

Surgical Gown
Doctor Set



Surgical Gown

Colors Available: ● blue



Feature: Sterilized by EO, individual paper pouch packing Velcro at neck with 4 waist belts, cotton cuffs, Any other specifications are available on request.

Code	N306-U1
Description	Sterile surgical gown, standard, with hand towel
Size	S-XXL
Material	SMS / SMMS / SMMMS
Packing	1×30



Code	N306-U3
Description	Sterile surgical gown, reinforced at chest and half sleeve, with hand towel
Size	S-XXL
Material	SMS / SMMS / SMMMS
Packing	1×30



Code	N306-U4
Description	Sterile surgical gown, reinforced at full chest and full sleeve, with hand towel
Size	S-XXL
Material	SMS / SMMS / SMMMS
Packing	1×30

sales@leboo.com.cn

Surgical Gown

Colors Available: ● blue



Code	N309
Description	Spunlace Surgical gown, standard, with hand towel
Size	S-XXL
Material	Pulp Spunlace
Packing	1×30

Doctor Set

Colors Available: ● blue



Code	N3171	N333	N334
Description	Doctor set, Regular style	SMS T-shirt	SMS pant, with string or elastic at waist
Size	S-XXL	S-XXL	S-XXL
Material	SMS	SMS	SMS
Packing	1×50	10×5	10×5



Surgical Drape and Pack

- Basic Pack
- Universal Pack
- Laparotomy Pack
- C-Section Pack
- Delivery Pack
- Orthopedic Pack
- Eye Pack
- Dental Pack
- Arthroscopy Pack
- Extremity Pack
- Angiography Pack
- Surgical Drape

Fabric:



Fabric Picture



Our fabric conforms to EN13795



Basic Pack 001 N7600-001

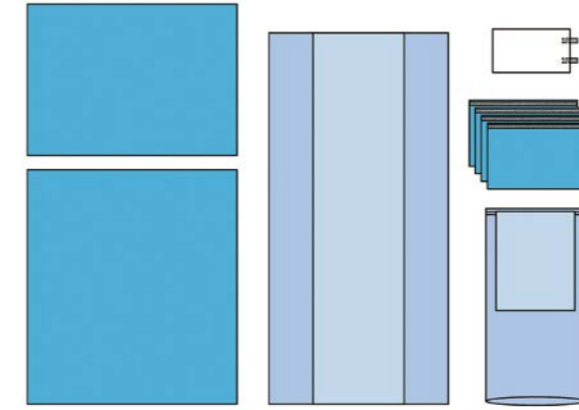

Basic Pack 002 N7600-002

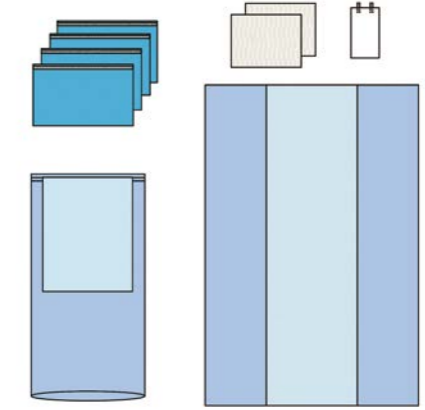

Specification	Size (cm)	Qty
Table Cover	150x200 (75x200)	1
Mayo Stand Cover	58x137 (48x60)	1
Utility Drape with Adhesive	38x66	4
Drape Sheet	105x150	1
Drape Sheet	150x160	1
Suture Bag	16x28	1

1pc/pouch, 16pouches/ctn All the pack can be customized

Specification	Size (cm)	Qty
Table Cover	140x210 (60x210)	1
Mayo Stand Cover	58x137 (48x60)	1
Utility Drape	38x66	4
Suture Bag	16x28	1
Hand Towel	30x40	2

1pc/pouch, 32pouches/ctn All the pack can be customized

Universal Pack 001 N7601-001

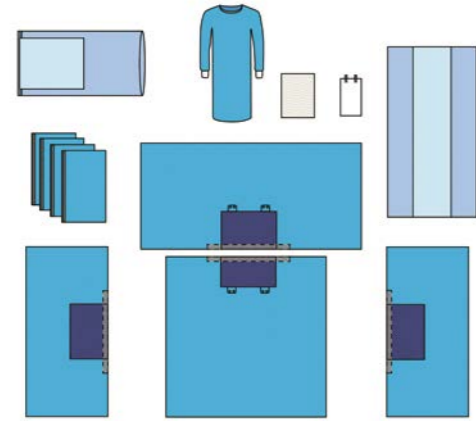

Universal Pack 002 N7601-002

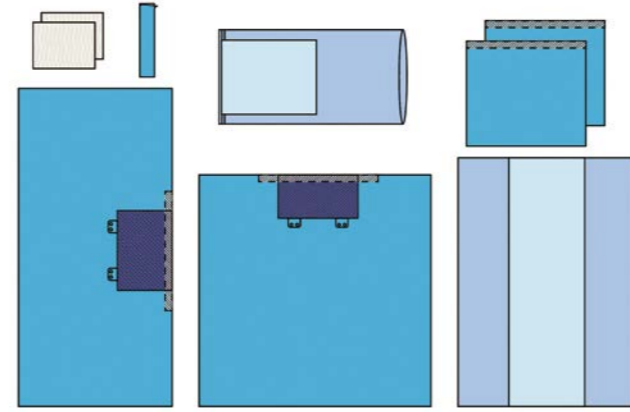

Laparotomy Pack 001 N7602-001

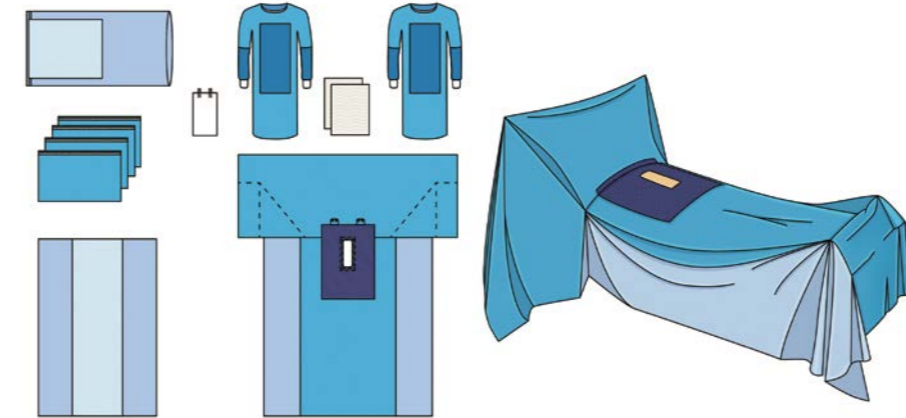

Laparotomy Pack 002 N7602-002

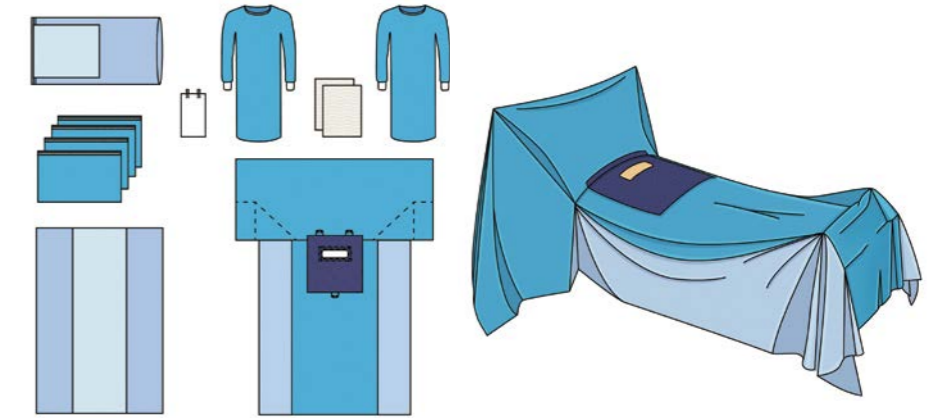

Universal Pack 001 N7601-001

Specification	Size (cm)	Qty
Table Cover	140x210 (60x210)	1
Mayo Stand Cover	58x137 (48x60)	1
Standard SMS Gown L	125x145	1
Utility Drape with Adhesive	38x66	4
Side Drape Reinforced ,with Adhesive	196x94 (64x43)	2
Head Drape Reinforced ,with Adhesive	249x135 (64x38)	1
Foot Drape Reinforced ,with Adhesive	188x180 (64x38)	1
Suture Bag	16x28	1
Hand Towel	30x40	1

1pc/pouch, 6pouches/ctn All the pack can be customized

Specification	Size (cm)	Qty
Table Cover	150x200 (75x200)	1
Mayo Stand Cover	76x145 (48x60)	1
Top Drape Reinforced ,with Adhesive	180x240 (38x64)	1
Side Drape	100x90	2
Bottom Drape Reinforced ,with Adhesive	180x180 (38x64)	1
Tape Strip (op-tape)	10x50	1
Hand Towel	30x40	2

1pc/pouch, 12pouches/ctn All the pack can be customized

Specification	Size (cm)	Qty
Table Cover	140x210 (60x210)	1
Mayo Stand Cover	58x137 (48x60)	1
SMS Reinforced Gown, L	125x145	2
Utility Drape with Adhesive	38x66	4
Laparotomy Drape	254(196)x 305	1
Suture Bag	16x28	1
Hand Towel	30x40	2

1pc/pouch, 8pouches/ctn All the pack can be customized

Laparotomy Pack 002 N7602-002

Specification	Size (cm)	Qty
Table Cover	140x210 (60x210)	1
Mayo Stand Cover	58x137 (48x60)	1
Standard SMS Gown L	125x145	2
Utility Drape with Adhesive	38x66	4
Laparotomy Drape	267(196) x353	1
Suture Bag	16x28	1
Hand Towel	30x40	2

1pc/pouch, 6pouches/ctn All the pack can be customized

C-Section Pack 001 N7603-001

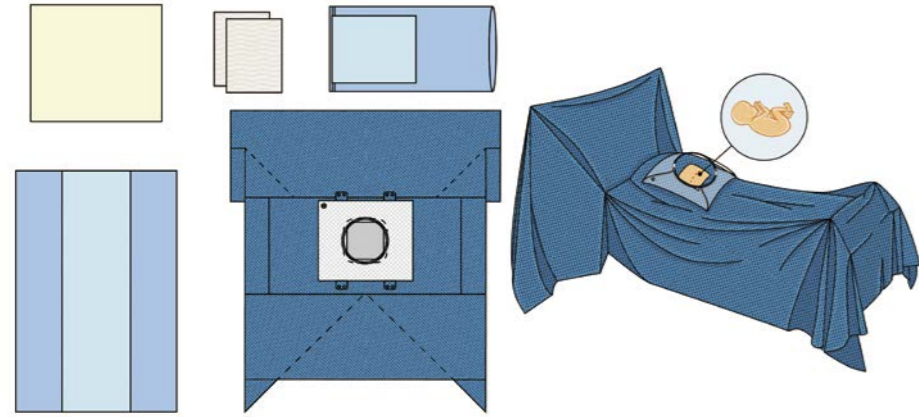

Specification	Size (cm)	Qty
Table Cover	140x210 (60x210)	1
Mayo Stand Cover	76x145 (48x60)	1
C-Section Drape , with Liquid Pouch	252x281	1
Baby Drape	90x80	1
Hand Towel	30x40	2

1pc/pouch, 7pouches/ctn All the pack can be customized

Delivery Pack 001 N7604-001

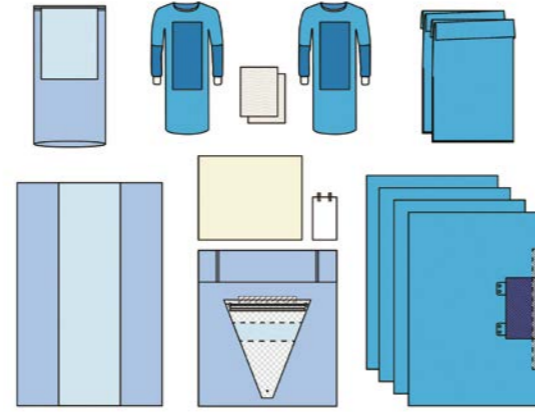

Specification	Size (cm)	Qty
Table Cover	140x190 (60x190)	1
Mayo Stand Cover	58x137 (48x60)	1
SMS Reinforced Gown, L	125x145	2
Adhesive Drape with Reinforcement	100x150 (23x40)	4
Under Buttock Drape with Liquid Pouch	102x112	1
Leggings	80x120	2
Suture Bag	16x28	1
Baby Drape	90x75	1
Hand Towel	30x40	2

1pc/pouch, 8pouches/ctn All the pack can be customized

Orthopedic Pack 001 N7605-001

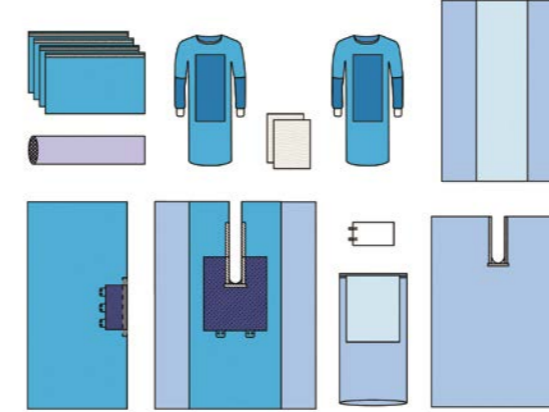

Specification	Size (cm)	Qty
Table Cover	140x210 (60x210)	1
Mayo Stand Cover	58x137 (48x60)	1
SMS Reinforced Gown, L	125x145	2
Utility Drape with Adhesive	38x66	4
PE Split Drape	152x213	1
Split Drape	196x250	1
Top Drape	135x251	1
Suture Bag	16x28	1
Stockinette	23x122	1
Hand Towel	30x40	2

1pc/pouch, 8pouches/ctn All the pack can be customized

Orthopedic Pack 002 N7605-002

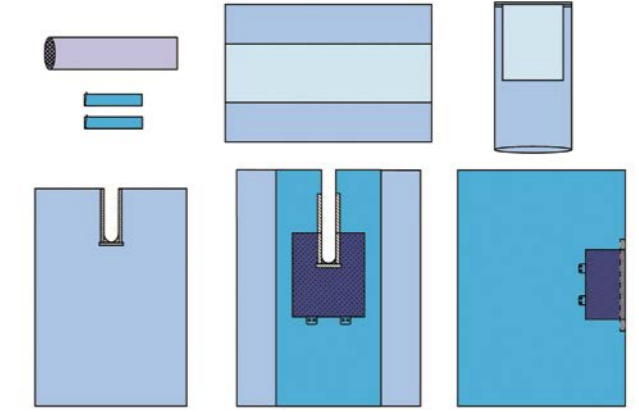

Specification	Size (cm)	Qty
Table Cover	140x210 (60x210)	1
Mayo Stand Cover	58x137 (48x60)	1
PE Split Drape	150x180	1
Split Drape Split	200x300	1
Top Drape	240x180	1
Stockinette	23x122	1
Tape Strip	10x50	2

1pc/pouch, 10 pouches/ctn All the pack can be customized

Eye Pack 001 N7606-001

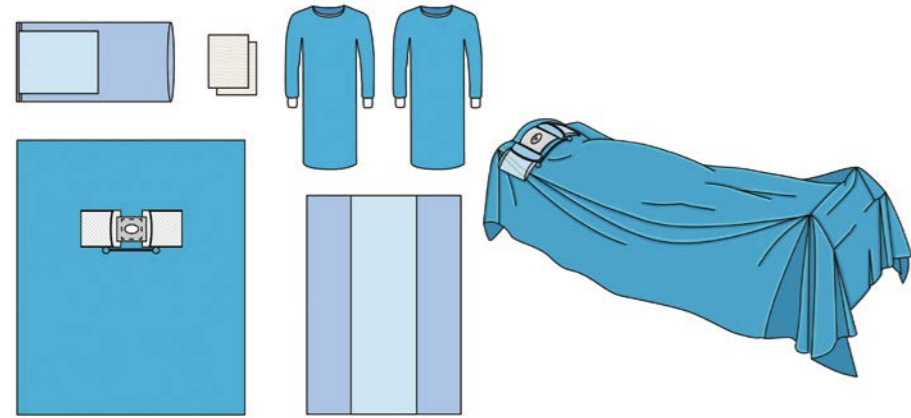

Specification	Size (cm)	Qty
Table Cover	140x210 (60x210)	1
Mayo Stand Cover	58x137 (48x60)	1
Standard SMS Gown L	125x145	2
Eye Drape , with Liquid Pouch, Incise Tape	150x180	1
Hand Towel	30x40	2

1pc/pouch, 16pouches/ctn All the pack can be customized

Dental Pack 001 N7607-001

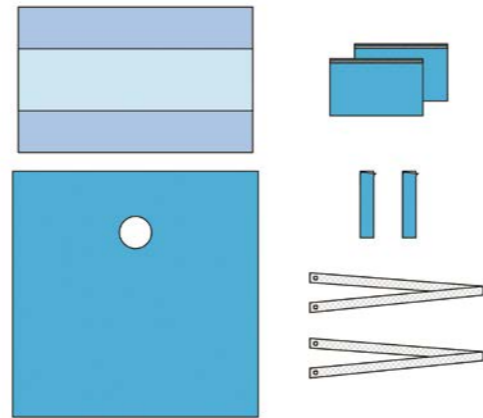

Specification	Size (cm)	Qty
Table Cover	140x210 (60x210)	1
Utility Drape	38x66	2
Tape Strip (op-tape)	10x50	2
Dental Drape	150x150	1
Tube cover	8x120	2

1pc/pouch, 32pouches/ctn All the pack can be customized

Arthroscopy Pack 001 N7608-001

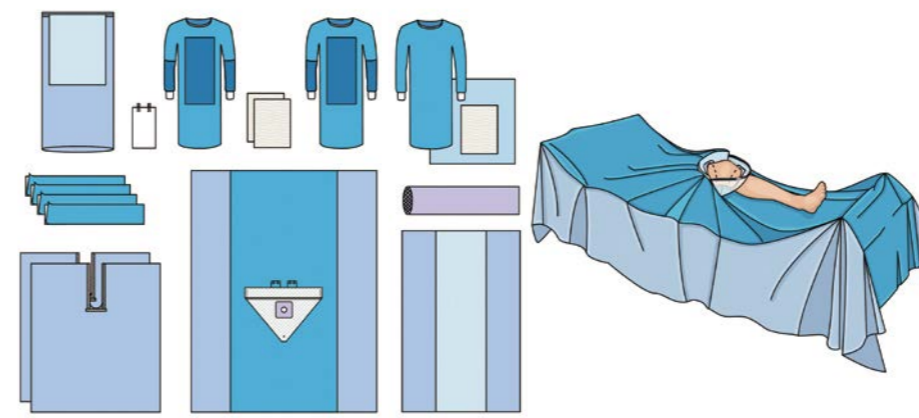

Specification	Size (cm)	Qty
Table Cover	140x210 (60x210)	1
Mayo Stand Cover	58x137 (48x60)	1
Standard SMS Gown L with Towel in Wrap	125x145	1
SMS Reinforced Gown, L	125x145	2
PE Split Drape	152x178	2
Arthroscopy Drape, with Liquid Pouch	230x300	1
Suture Bag	16x28	1
Tape Strip (op-tape)	10x50	4
Stockinette	23x122	1
Hand Towel	30x40	2

1pc/pouch, 6pouches/ctn All the pack can be customized

Extremity Pack 001 N7609-001

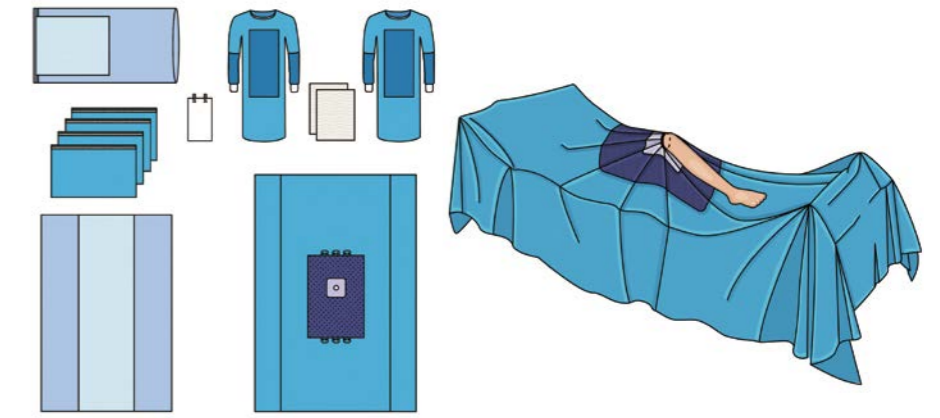

Specification	Size (cm)	Qty
Table Cover	140x210 (60x210)	1
Mayo Stand Cover	58x137 (48x60)	1
SMS Reinforced Gown, L	125x145	2
Utility Drape with Adhesive	38x66	4
Extremity Drape	220x318	1
Suture Bag	16x28	1
Hand Towel	30x40	2

1pc/pouch, 9pouches/ctn All the pack can be customized

Angiography Pack 001 N7610-001

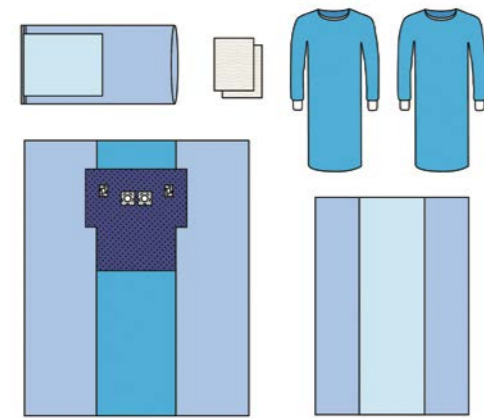

Specification	Size (cm)	Qty
Table Cover	140x210 (60x210)	1
Mayo Stand Cover	58x137 (48x60)	1
Standard SMS Gown L	125x145	2
Angiography Drape	310x380	1
Hand Towel	30x40	2

1pc/pouch, 9pouches/ctn All the pack can be customized

Angiography Pack 002 N7610-002

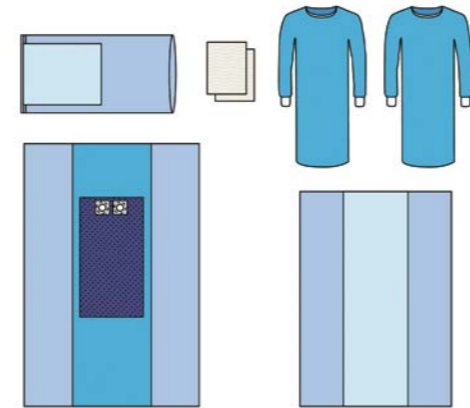

Specification	Size (cm)	Qty
Table Cover	140x210 (60x210)	1
Mayo Stand Cover	58x137 (48x60)	1
Standard SMS Gown L	125x145	2
Angiography Drape	220x330	1
Hand Towel	30x40	2

1pc/pouch, 9 pouches/ctn All the pack can be customized

Surgical Drape

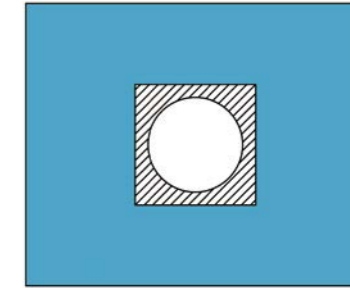
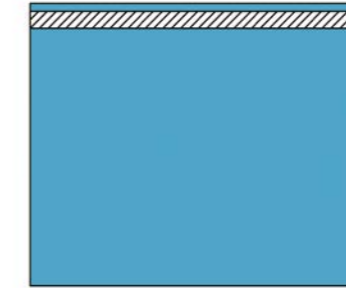
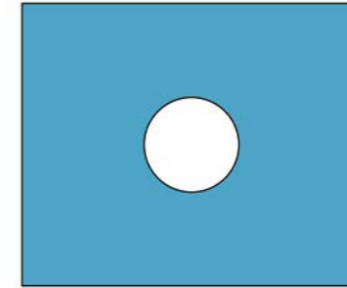

Standard Drape SMS / PP+PE film / Viscose+PE film 1pc/pouch, sterilized by EO

Ref.	Size(cm)	Pieces per ctn
N7210-1	40x60	200
N7210-2	50x75	200
N7210-3	75x75	200
N7210-4	75x90	100
N7210-5	100x150	100
N7210-6	110x190	100
N7210-7	150x200	50

Drape with Adhesive Side SMS / PP+PE film 1pc/pouch, sterilized by EO

Ref.	Size(cm)	Pieces per ctn
N7310-1	40x60	200
N7310-2	50x75	200
N7310-3	75x75	200
N7310-4	75x90	100
N7310-5	100x150	100
N7310-6	110x190	50
N7310-7	150x200	50

Drape with Adhesive Aperture SMS / PP+PE film 1pc/pouch, sterilized by EO

Ref.	Size(cm)	Aperture ϕ (cm)	Pieces per ctn
N7311-1	40x60	6	200
N7311-2	50x75	6	200
N7311-3	75x75	6	200
N7311-4	75x90	6x8	100
N7311-5	100x150	5x7	100
N7311-6	150x200	6x15	50
N7311-7	200x240	12	30

Gown

Isolation Gown
Patient Gown
Lab Coat
Covercall
PE Apron



Isolation Gown

Colors Available: white blue yellow green

Any gram, size, material or style are available



With Knitted Cuff

Code	N302
Description	Isolation gown, with knitted cuff
Size	S-XL
Material	PP
Packing	10×10



With Elastic Cuff

Code	N301
Description	Isolation gown, with elastic cuff
Size	S-XL
Material	PP
Packing	10×10



Other Style

Code	N303
Description	Isolation gown, full coated
Size	S-XL
Material	PP+PE
Packing	10×10

Patient Gown

Colors Available: ● blue ● dark blue



Code	N318	N319
Description	Patient gown, short sleeve	Patient gown, without sleeve
Material	PP	PP
Packing	10×10	10×10

Any gram, size, material or style are available

Lab coat

Colors Available: ○ white ● blue ● green



Code	N313
Description	Lab coat, with 4 press-buttons
Material	PP
Packing	10×10



Code	N314
Description	Lab coat, with 4 velcro fastenings
Material	PP
Packing	10×10

Coverall

Colors Available: ○ white ● blue ● green



With hood

Feature: Front zipper, with elastic at waist, cuff and ankle, without boot cover

Code	N310	N311
Description	Coverall, with hood	Coverall, with hood, with zipper flap
Size	S-XXL	S-XXL
Material	PP	PP
Packing	10×5	10×5

PE Apron

Colors Available: ○ white ● blue ● green ○ clear ● yellow ● red ● pink



Any Size and Thickness are Available

Code	Description	Material	Packing
C501	LDPE apron, flat packed	LDPE	100×10
C502	LDPE apron, flat packed in box	LDPE	100×10boxes
C503	HDPE apron, flat packed	HDPE	100×10

Cap

Surgeon Cap
Bouffant Cap
Mob Cap
Surgical Hood
Astro Cap



Surgeon Cap

Colors Available: ● blue ● green



Feature: Universal sizes to fit all.

Code	Description	Material	Packing
N109	Surgeon cap, 1ply, with fixed ties	PP	100×10

Bouffant Cap

Colors Available: ○ white ● blue ● green



Code	Description	Size	Material	Packing
N101	Bouffant cap	18"	PP	100×10
N102	Bouffant cap	21"	PP	100×10
N103	Bouffant cap	24"	PP	100×10

Mob Cap

Colors Available: ○ white ● blue ● green



Code	Description	Size	Material	Packing
N104	Mob cap, single elastic	18"	PP	100×10
N105	Mob cap, single elastic	21"	PP	100×10
N106	Mob cap, single elastic	24"	PP	100×10
N107	Mob cap, double elastic	21"	PP	100×10

Astro cap, with facemask

Colors Available: white blue green



Code	N139
Description	Astro cap, with 2 ply facemask
Material	PP
Packing	100x5

Surgical Hood

Colors Available: white blue green spunlace



Code	N114
Description	Surgical hood (astronaut hood)
Material	PP
Packing	100x10



Face Mask

Nonwoven Face Mask

Nonwoven Face Mask

Colors Available: ○ white ● blue ● green

Leboos Pursuit: Exceeding Your Expectations



Code	Description	Material	Packing
N203	Face mask, 3-layers, with earloops	PP+filter paper+PP	50×40

Code	Description	Material	Packing
N204	Face mask, 3-layers, with ties	PP+filter paper+PP	50×40



Glove
PE Glove

PE Glove

Colors Available: clear blue



size: M, L, Embossed/Smooth Surface

Code	Description	Color	Material	Packing
C201	LDPE glove	Clear	LDPE	100×100
C202	LDPE glove	Blue	LDPE	100×100
C203	HDPE glove	Clear	HDPE	100×100

Shoe Cover and Sleeve Cover

CPE Shoe Cover
Nonwoven Shoe Cover
Non-skid PP Shoe Cover
PP+CPE Shoe Cover
PE Boot Cover
PE Sleeve Cover



CPE Shoe Cover

Colors Available: white blue green



Any size, any thickness are available

Code	Description	Material	Packing
C401	CPE shoe cover, hand made	CPE	100×20
C405	CPE shoe cover, machine made	CPE	100×20

Nonwoven Shoe Cover

Colors Available: white blue green



Code	Description	Material	Packing
N401	Nonwoven shoe cover	PP	100×10

Non-skid PP Shoe Cover

Colors Available: white blue green



Code	Description	Material	Packing
N402	Non-skid PP shoe cover	PP	100×10

PP+CPE Shoe Cover

Colors Available: white blue



Code	Description	Material	Packing
N404	PP+CPE shoe cover, white+blue	PE+CPE	100×10

Boot Cover

Colors Available: white blue clear



Code	Description	Size	Material	Packing
C409	PE boot cover	40×50cm	LDPE	100×5

PE Sleeve Cover

Colors Available: white blue green



Code	Description	Material	Packing
C601	Sleeve cover, hand made	PE	100×20
C602	Sleeve cover, machine made	PE	100×20

Bed Sheet

Bed Sheet
Pillow Case
PE Mattress Cover



Bed Sheet

Colors Available: white blue green



Code	Description	Material	Packing
N701	Nonwoven bed sheet, any size	PP	10×10
N703	PE coated PP bed sheet	PP+PE	10×10

Pillow Case

Colors Available: white blue green



Code	Description	Material	Packing
N707	Pillow case	PP	10×20
N708	Pillow case with slip	PP	10×20

PE Mattress Cover

Colors Available: blue



Code	Description	Size	Material	Packing
C704	CPE mattress cover	210×90×20cm	CPE	10×20
C713	PE tray cover	85×125×25cm	LDPE	10×20
C714	PE tray cover	105×125×25cm	LDPE	10×20

Leboo Certificates

Leboos Pursuit: Exceeding Your Expectations



Exceeding Your Expectations



Leboo Healthcare Products Limited

H.O.: A-1506, Lar Valley International, No.168 Guang'anmen Wai St., Xicheng District, Beijing 100055, China.
Factory: Linwan Industrial Park, Xiantao City, 433018, Hubei Province, China
Factory: Penchang Xuwan Industrial Park, Xiantao City, 433018, Hubei Province China

T: +86 10 63252699 F: +86 10 63252899
Email: sales@leboo.com.cn